



4G LTE SMD Corner Mounted Antenna

SZP-C-1L12

4G LTE/3G/2G: 698-960; 1710-2200; 2300-2400; 2500-2690MHz



Name: ARRAKIS a

Part Number: SZP-C-1L12

Description: 4G LTE Surface Mount Device Antenna

- SMD PCB Antenna using precision laminate materials
- Dimensions: 30.0 x 7.0 x 3.3 (mm)
- RoHS & Reach Compliant, Halogen free



4G LTE SMD Corner Mounted Antenna

SZP-C-1L12

4G LTE/3G/2G: 698-960; 1710-2200; 2300-2400; 2500-2690MHz

Description

A compact and high performing solution for smaller devices. A complete solution for global 4G LTE applications.

- Suitable for Diversity applications
- Ideal for small PCB size <110mm
- For 4G LTE Applications, but also backward compatible for 3G/2G systems
- Less dependency on GND plane length
- SMD component supplied in Tape and reel
- Higher performance than larger OTS solutions
- Project life support Direct from Synzen Engineers
- Suitable for sealing with resin / potting compounds



Applications

Telematics
Smart City
Drones

Smart Metering
Gateways
POS

Home Automation
Healthcare
OBD-II



30.0 x 7.0 x 3.3 (mm)



Patent pending design



General Specifications

Mechanical Specifications

Part Number	SZP-C-1L12
Name	ARRAKIS a
Dimensions	30.0 x 7.0 x 3.3 (mm)
Required Clearance area	310 mm ²
Weight	<1.8g
Antenna Type	Surface Mount Device

RF Specifications

130mm PCB length				
Frequency Range (MHz)	698-960	1710-2200	2300-2400	2500-2690
Average Efficiency (Linear)	>60%	>65%	>55%	>60%
Peak Gain (dBi)	2.20	3.20	3.15	3.15
S11 (max) dB	<-5.0	<-8.0	<-6.0	<-7.5
VSWR (max)	3.6:1	2.6:1	3.2:1	2.9:1
Impedance	50 Ω			
Polarization	Linear			

The data shown was measured on Synzen DVK (SZDV-C-1L12)

100mm PCB length				
Frequency Range (MHz)	698-960	1710-2200	2300-2400	2500-2690
Average Efficiency (Linear)	>35%	>50%	>40%	>60%
Peak Gain (dBi)	-0.20	1.30	1.20	2.60

The data shown was measured cut down DVK to 100mm length.

55mm PCB length				
Frequency Range (MHz)	698-960	1710-2200	2300-2400	2500-2690
Average Efficiency (Linear)	>12%	>50%	>40%	>50%
Peak Gain (dBi)	-3.00	1.70	1.30	1.30

The data shown was measured cut down DVK to 55mm length.

Environmental Specifications

Operational Temperature	-40 to +125 (°C)
Storage Temperature	-10 to +40 (°C)
Relative Humidity	≤75%



LTE Bands Covered by SZP-C-1L12

Supported band list

LTE Band	Frequency Band	Uplink (MHz)	Downlink (MHz)	Supported
1	2100	1920 – 1980	2110 – 2170	YES
2	1900	1850 – 1910	1930 – 1990	YES
3	1800	1710 – 1785	1805 – 1880	YES
4	1700	1710 – 1755	2110 – 2155	YES
5	850	824 – 849	869 – 894	YES
7	2600	2500 – 2570	2620 – 2690	YES
8	900	880 – 915	925 – 960	YES
10	1700	1710 – 1770	2110 – 2170	YES
11	1500	1427.9 – 1447.9	1475.9 – 1495.9	NO
12	700	699 – 716	729 – 746	YES
13	700	777 – 787	746 – 756	YES
14	700	788 – 798	758 – 768	YES
17	700	704 – 716	734 – 746	YES
18	850	815 – 830	860 – 875	YES
19	850	830 – 845	875 – 890	YES
20	800	832 – 862	791 – 821	YES
21	1500	1447.9 – 1462.9	1495.9 – 1510.9	NO
22	3500	3410 – 3490	3510 – 3590	NO
24	1600	1626.5 – 1660.5	1525 – 1559	NO
25	1900	1850 – 1915	1930 – 1995	YES
26	850	814 – 849	859 – 894	YES
27	800	807 – 824	852 – 869	YES
28	700	703 – 748	758 – 803	YES
29	700	N/A	717 – 728	YES
30	2300	2305 – 2315	2350 – 2360	YES
31		452.5 – 457.5	462.5 – 467.5	NO
32	1500	N/A	1452 – 1496	NO
33	2100	1900 – 1920		YES
34	2100	2010 – 2025		YES
35	1900	1850 – 1910		YES
36	1900	1930 – 1990		YES
37		1910 – 1930		YES
38	2600	2570 – 2620		YES
39	1900	1880 – 1920		YES
40	2300	2300 – 2400		YES
41	2500	2496 – 2690		YES
42	3500	3400 – 3600		NO
43	3700	3600 – 3800		NO
44	700	703 – 803		YES
45	1500	1447 – 1467		NO
46	5200	5150 – 5925		NO
47	5900	5855 – 5925		NO
48	3600	3550 – 3700		NO
50	1500	1432 – 1517		NO
51	1500	1427 – 1432		NO
65	2100	1920 – 2010	2110 – 2200	YES
66	1700	1710 – 1780	2110 – 2200[2]	YES
67	700	N/A	738 – 758	YES
68	700	698 – 728	753 – 783	YES
69	2600	N/A	2570 – 2620	YES
70	2000	1695 – 1710	1995 – 2020	NO



RF Characteristics

S11 Parameter

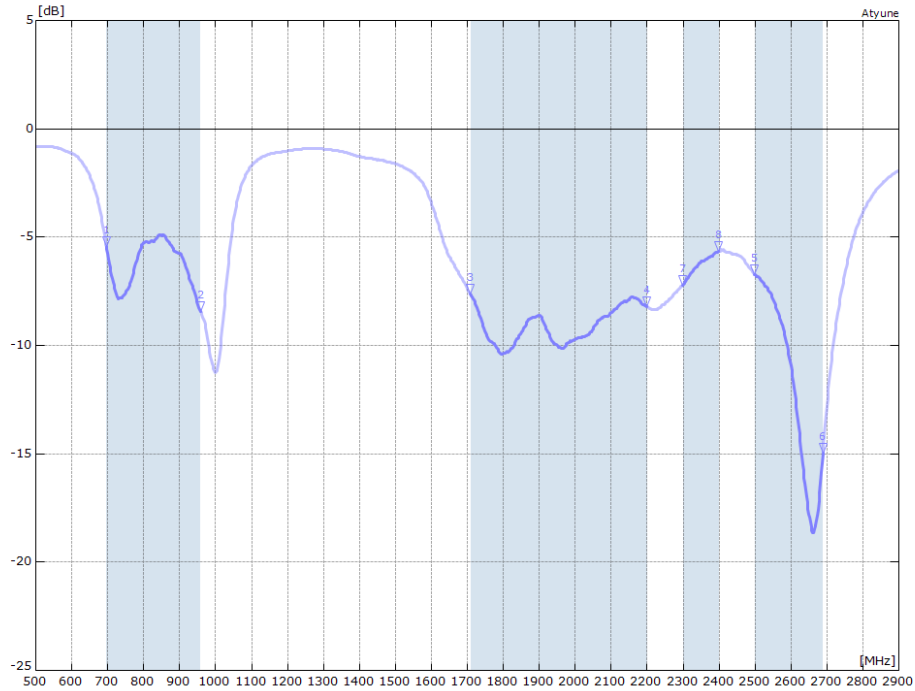

VSWR

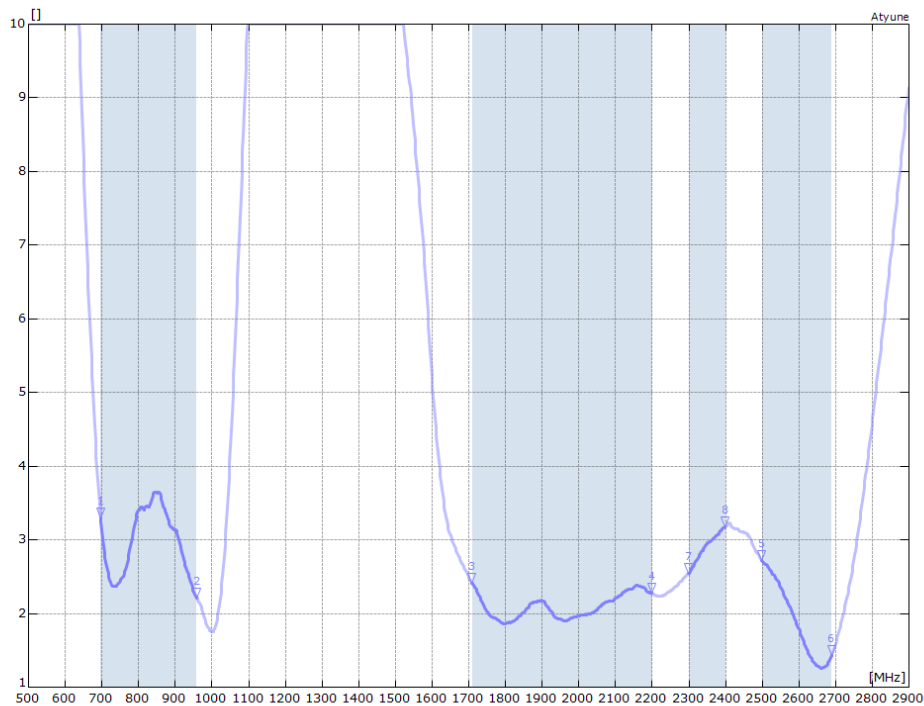



Radiated Performance

2D Polar Plot

The data shown was measured on Synzen DVK (SZDV-C-1L12)

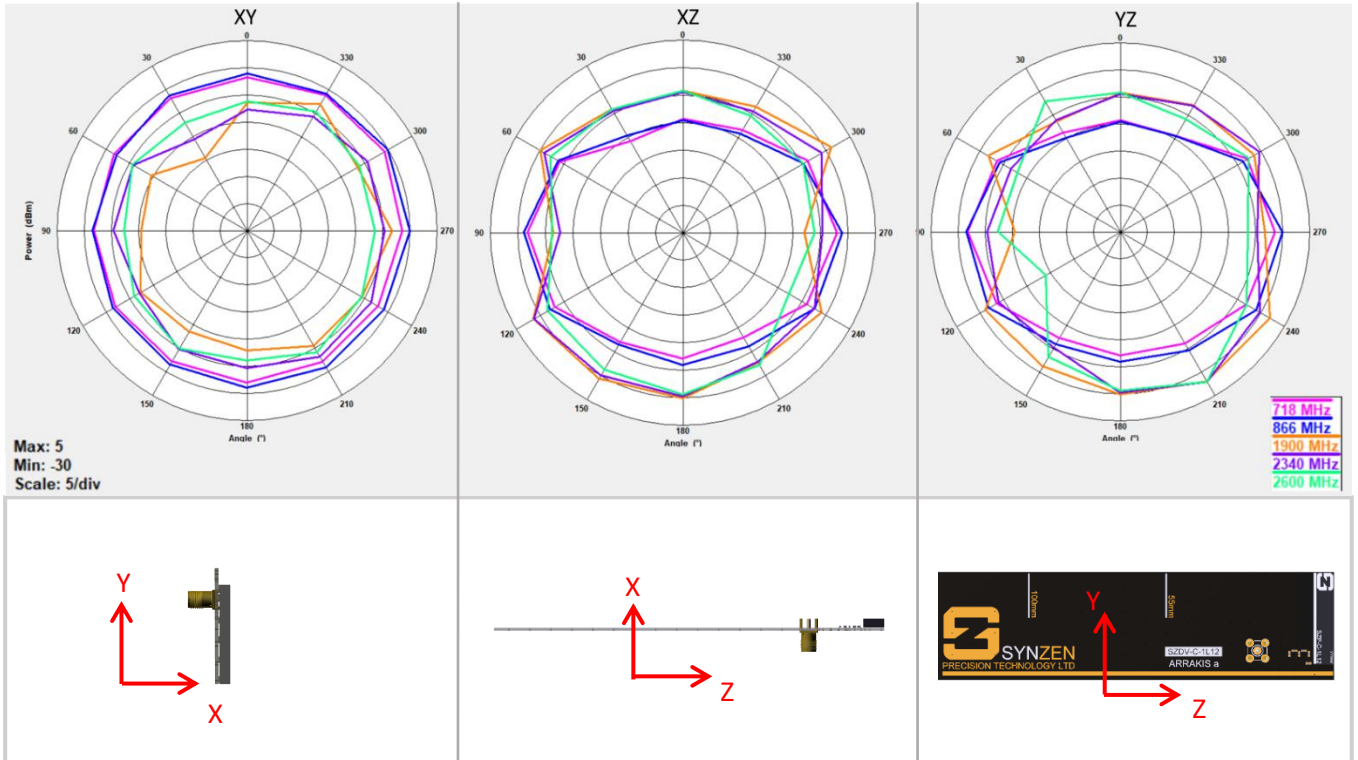



Radiated Performance

3D Radiation Pattern at 714MHz

The data shown was measured on Synzen DVK (SZDV-C-1L12).

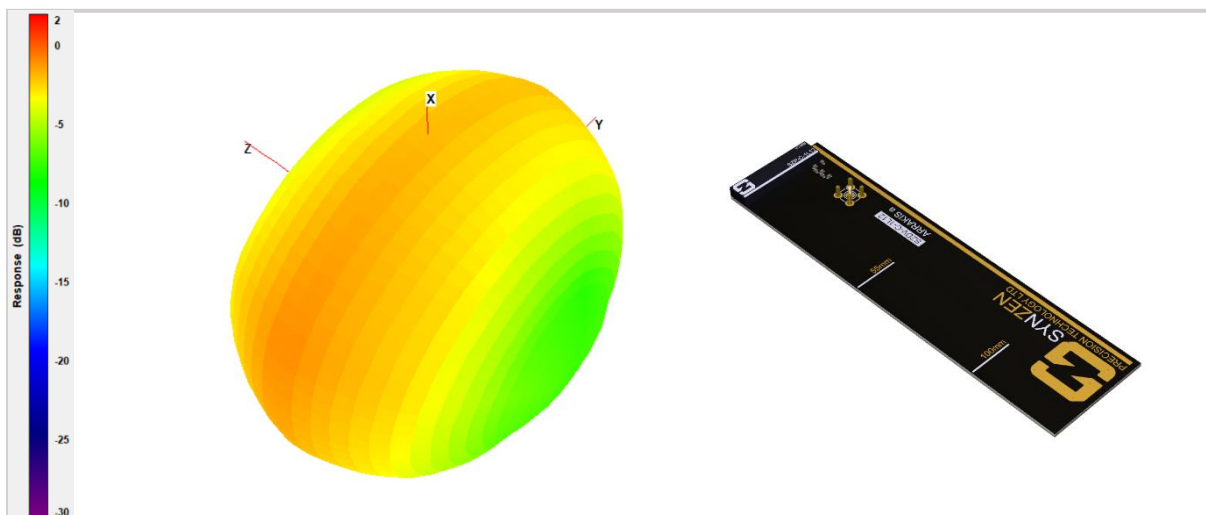
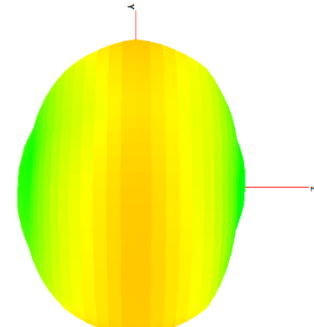
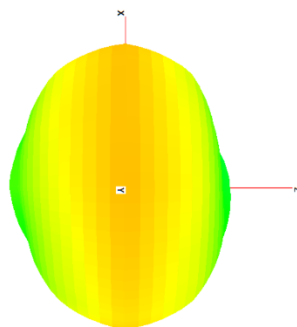
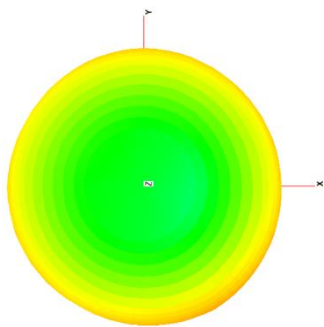
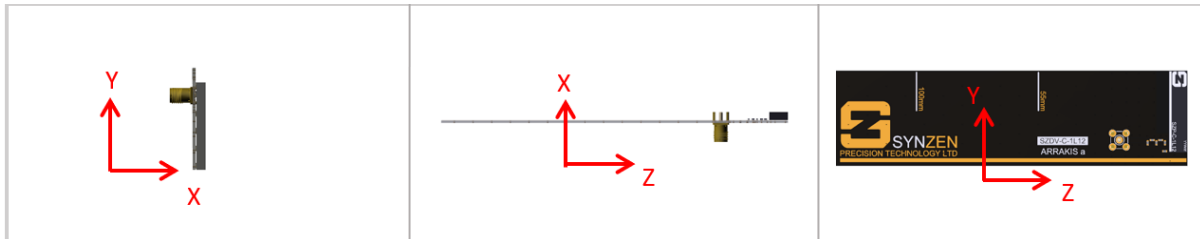



Radiated Performance

3D Radiation Pattern at 870MHz

The data shown was measured on Synzen DVK (SZDV-C-1L12).

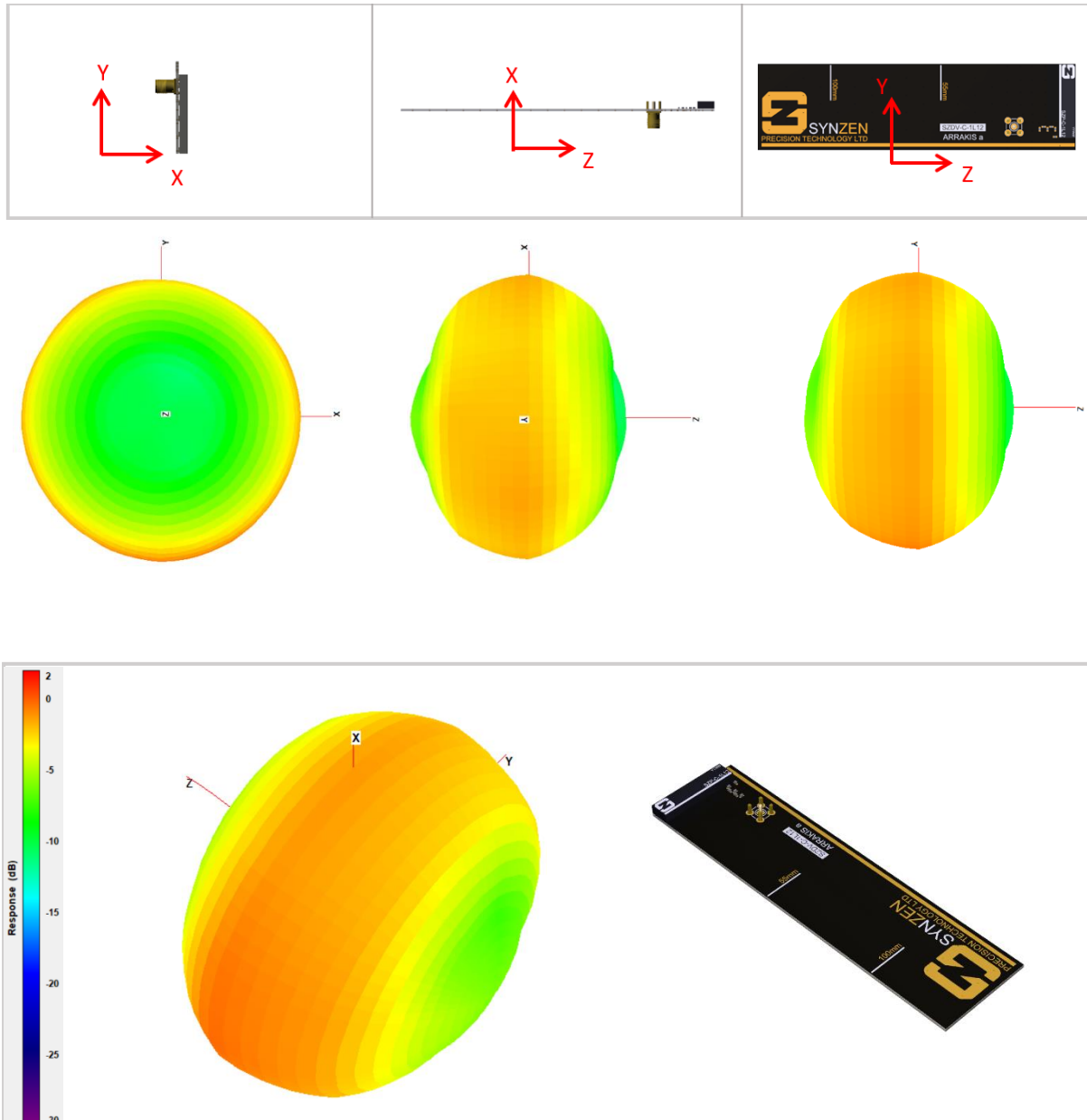



Radiated Performance

3D Radiation Pattern at 1880MHz

The data shown was measured on Synzen DVK (SZDV-C-1L12).

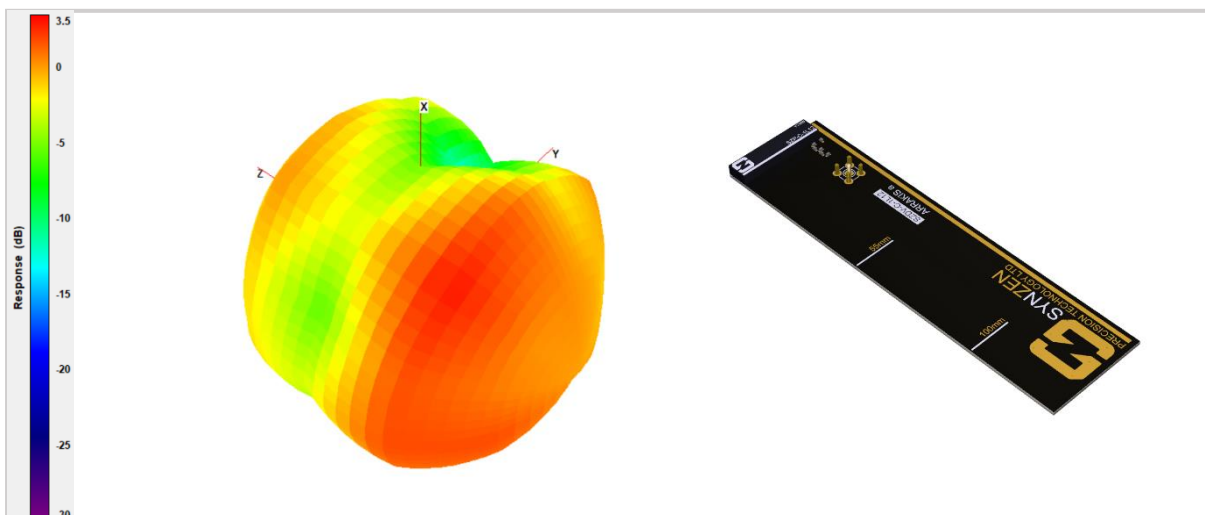
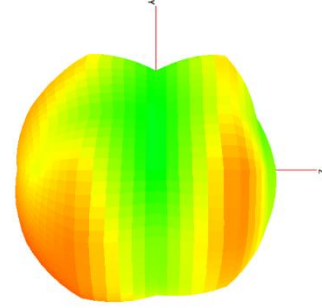
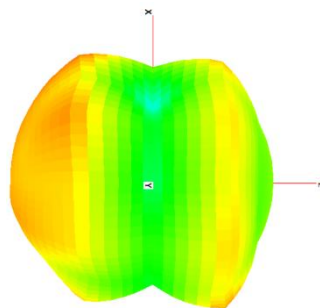
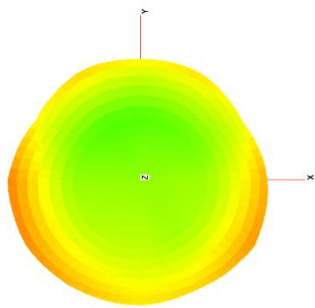
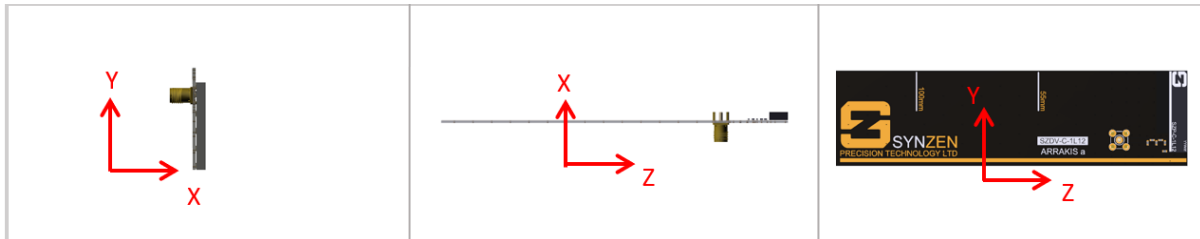



Radiated Performance

3D Radiation Pattern at 2600MHz

The data shown was measured on Synzen DVK (SZDV-C-1L12).

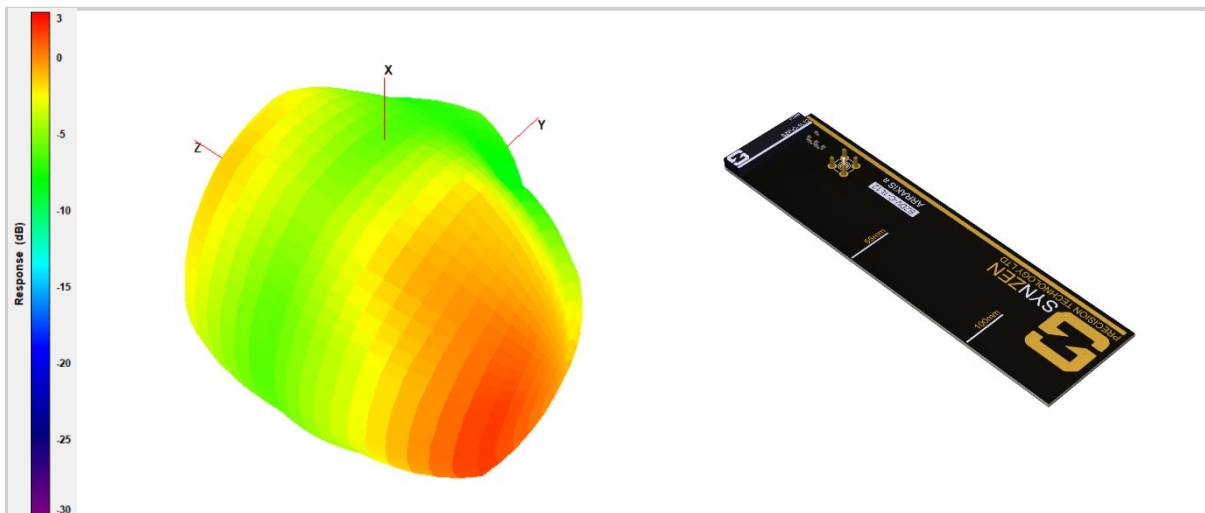
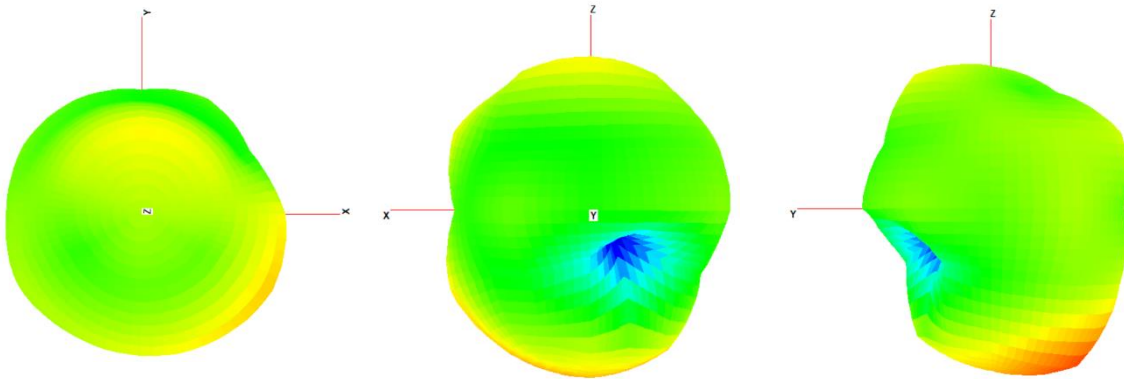
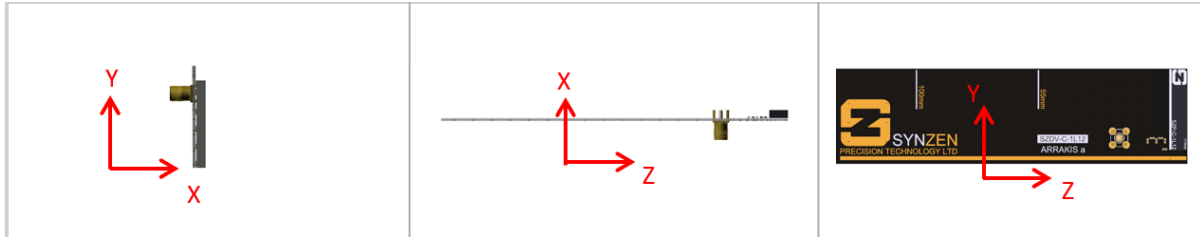

Efficiency Vs PCB Length

Antenna Efficiency Graph

The data shown was measured on Synzen DVK (SZDV-C-1L12). Full length of the DVK is 130mm. This was then cut down and measured at 100mm and 55mm for a direct comparison of Efficiency vs. PCB length.

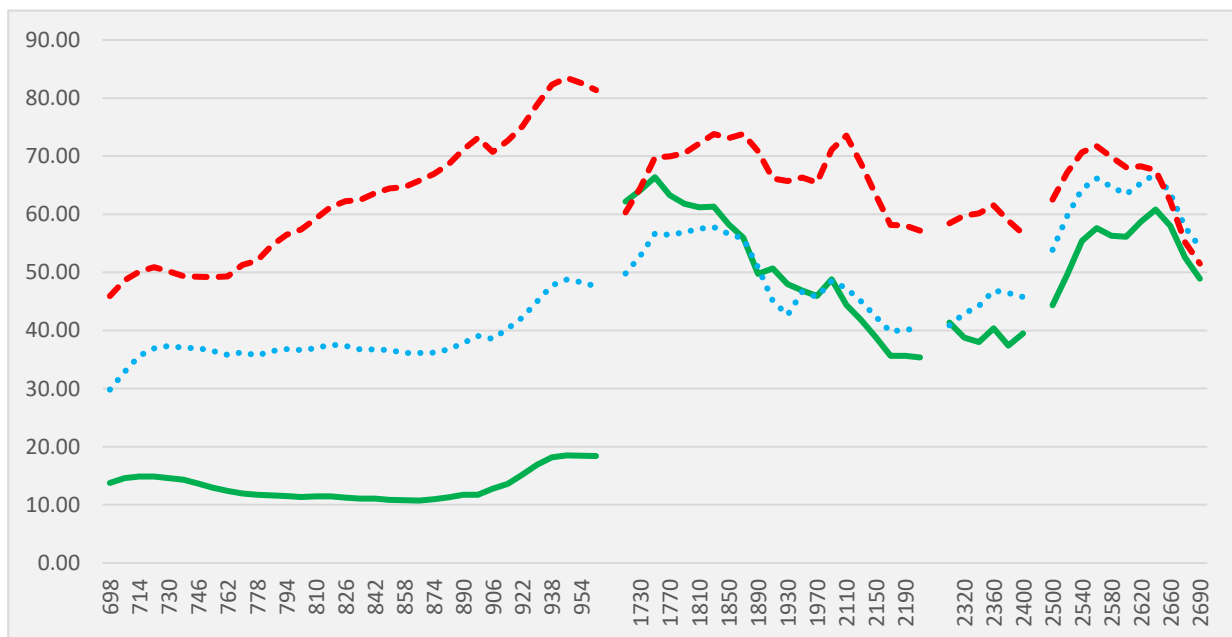
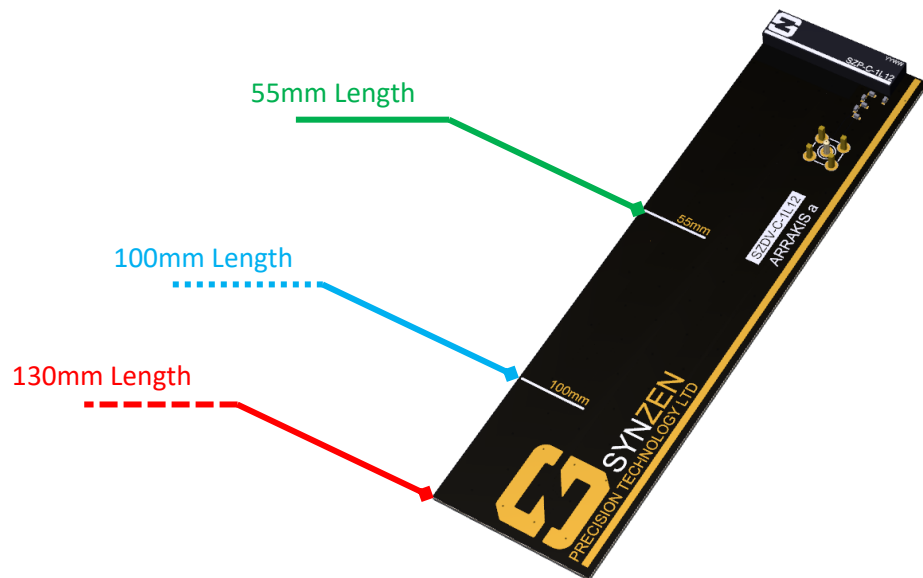

Mechanical

Antenna Mechanical Drawing

L	W	H
30.0±0.1	7.0±0.1	3.3±0.1

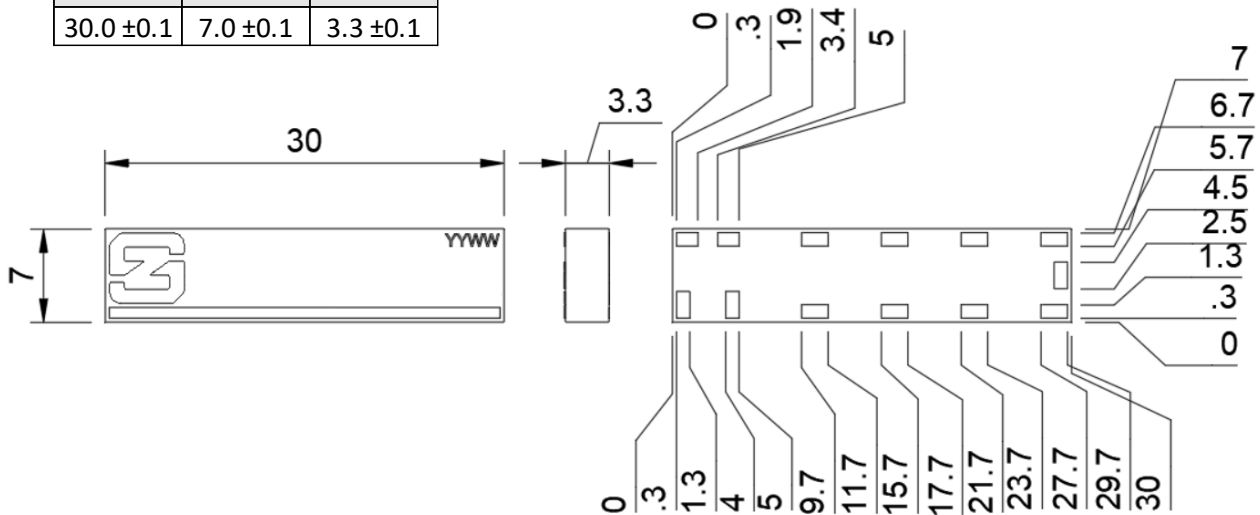

All dimensions in mm

Required Host PCB Footprint

The host PCB requires the footprint shown below. PCB library files and DXF is available from our website www.synzen.com.tw/products.

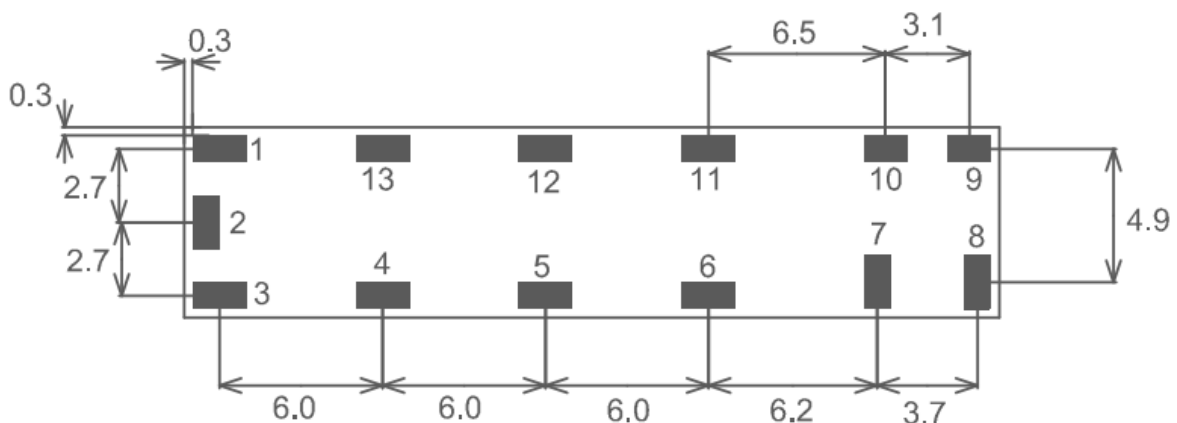

PADS 1,2,3,4,5,6,7,8,11,12,13 = 2.0 x 1.0

PADS 9,10 = 1.6 x 1.0

ALL DIMENSIONS IN MM



Antenna Pinout

SZP-C-1L12 Schematic Symbol

The schematic symbol for the antenna is shown below with a description of each pin.

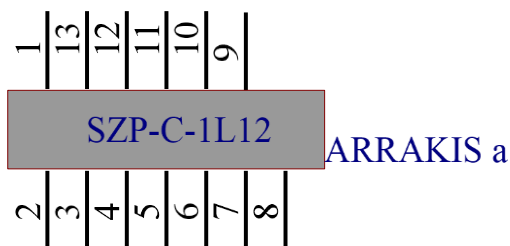

Pin	Description
1,2,3,4,5,6,9,10,11,12,13	Not used (Mechanical support)
7	Feed to Matching network
8	Tuning Return

Development Kit Mechanical

SZDV-C-1L12 Development Kit

The SZDV-C-1L12 development kit is a PCBA with the LTE antenna (SZP-C-1L12) fitted and optimised with a matching network. Connection to the antenna is made using the fitted female SMA connector.

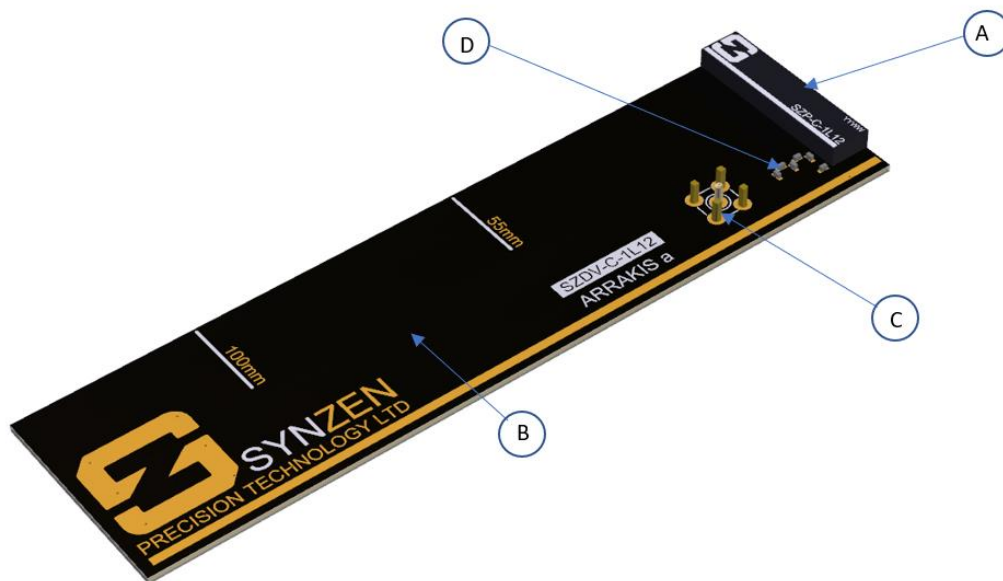
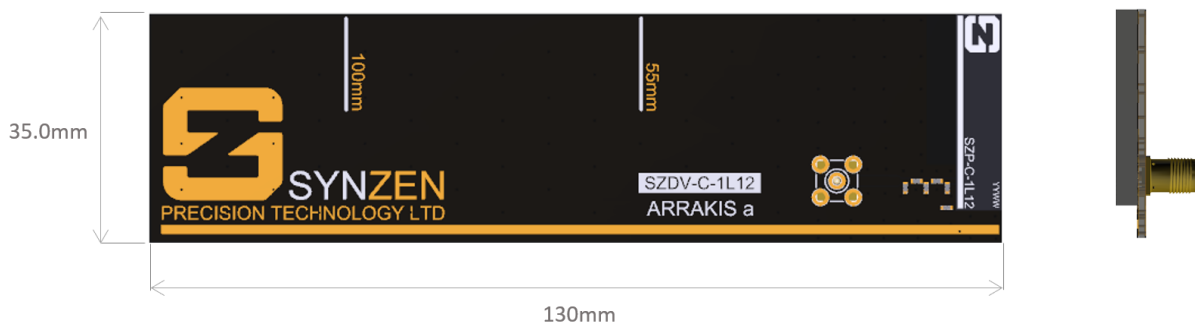

A	SZP-C-1L12 (ARRAKIS a)
B	Host PCB
C	SMA Connector
D	Matching Circuit

Development Kit Circuit

Development Kit Matching Circuit

The circuit of the DEV kit along with the BOM is shown below. The matching network topology should be used on the device host PCB although the matching values will be dependent on the host PCB and device environment. Synzen provide a matching service to optimise your device to ensure the best performance, please contact sales@synzen.com.tw for more information.

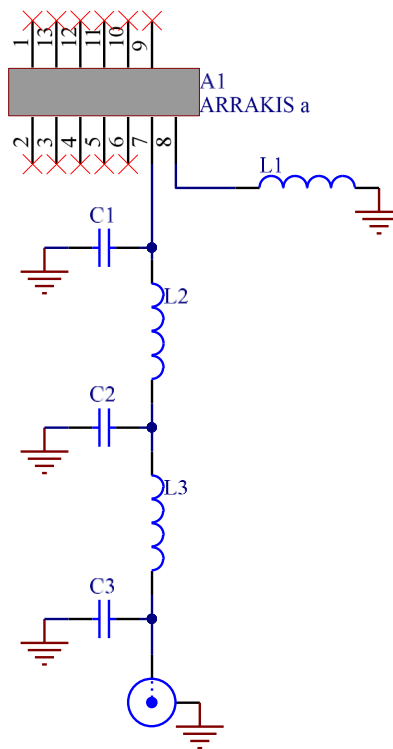

Designator	Component Type	Value	Size	Manufacturing Part No.
A1	Antenna	ARRAKIS a	-	SZP-C-1L12
L1	Inductor	5.6nH	0402	LQG15HS5N6H02D
C2, C3, L2	NA	DNP	0402	Do Not Place
C1	Capacitor	2.0pF	0402	GJM1555C1H2R0CB01D
L3	Inductor	3.0nH	0402	LQG15HS2N0J02D
J1	SMA Connector	-	-	ACE solution A3SAFTST135

Host PCB Placement and Clearance

Placement

The antenna is designed to function placed at the left side corner of the host PCB. For a right-hand side version see ARRAKIS b (SZP-C-1L13).

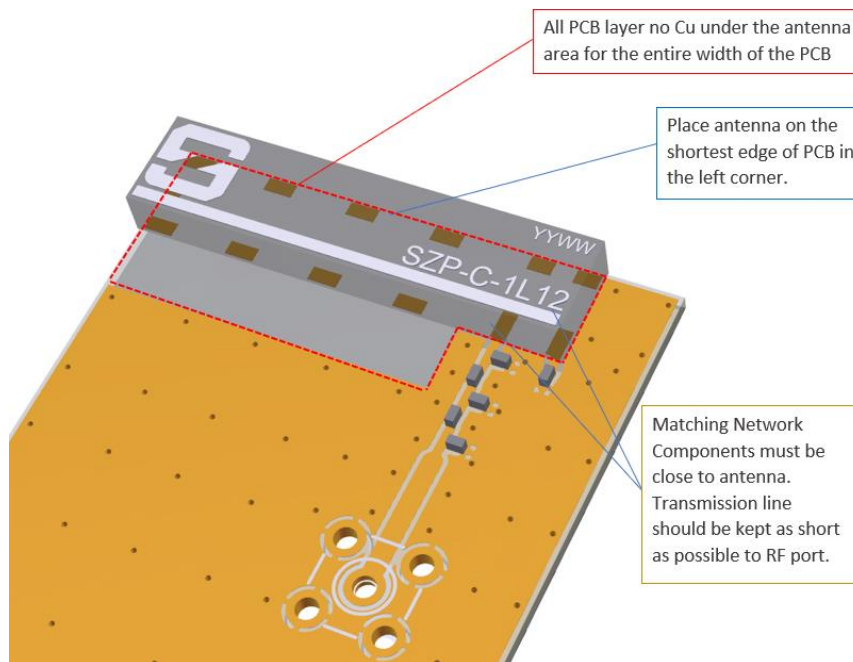

Clearance

A clearance is required through all PCB layers for the precise area shown. No components must be placed within this area otherwise RF coupling from the antenna to any conductor will occur reducing performance significantly. Also, any components such as battery or display must also avoid this area.

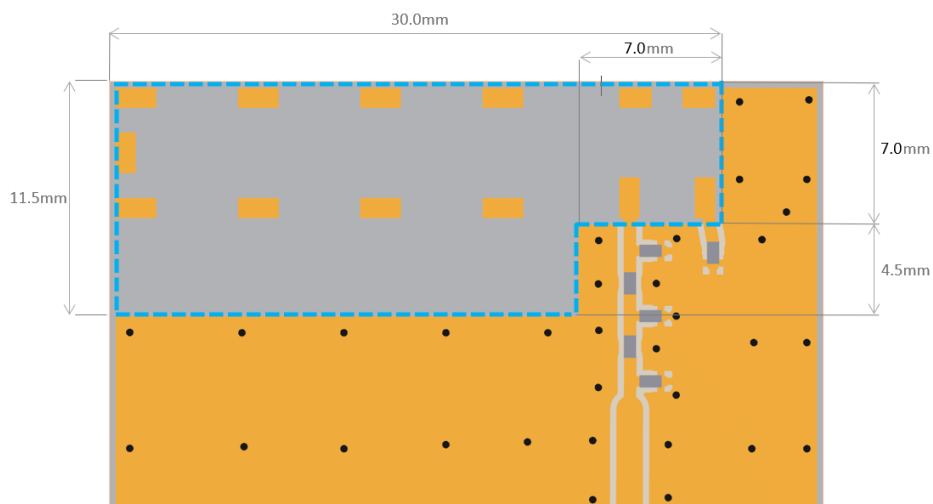

Soldering

Reflow Profile

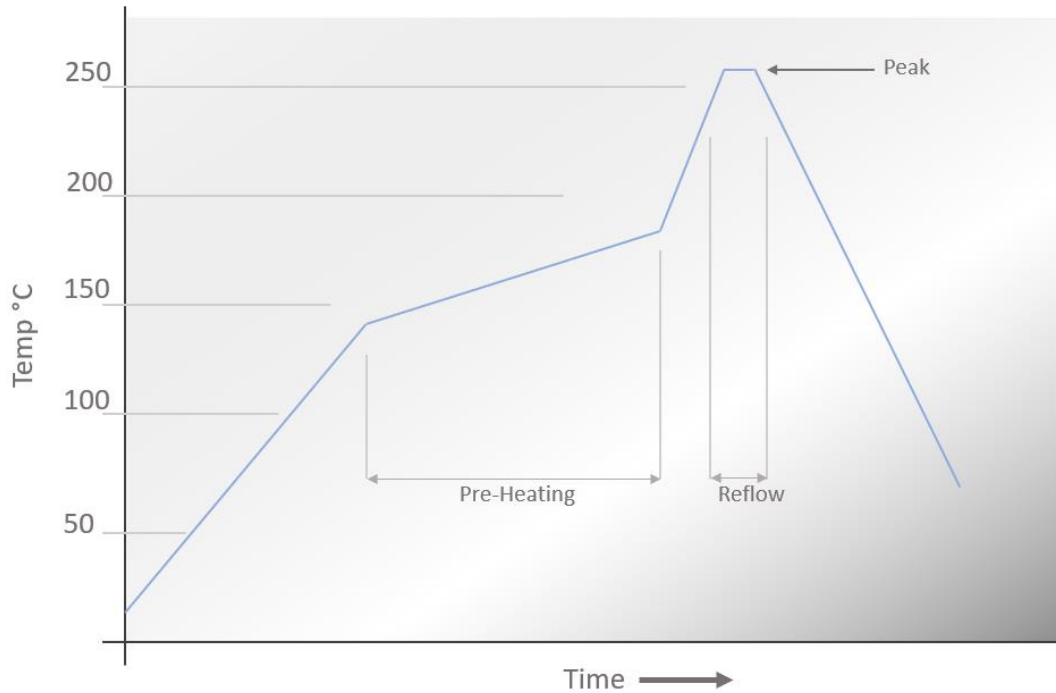

Pre-Heating	130 - 180°C	50 to 190 seconds
Reflow	>220 °C	50 to 160 seconds
Peak Temperature	260 °C	15 to 45 seconds

Packaging

Tape and Reel

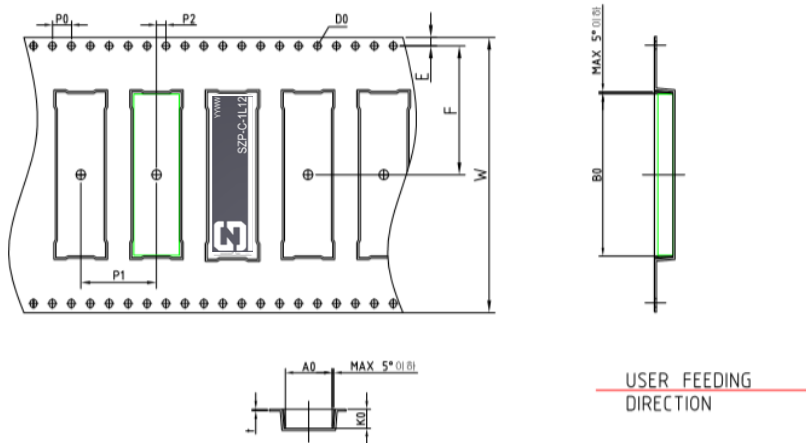

1. 10 sprocket hole pitch cumulative tolerance ± 0.2
2. Camber not to exceed 1mm in 100mm.
3. A0 and B0 measured on a plane 0.1mm above the bottom of the pocket
4. K0 measured from a plane on the inside bottom of the pocket to the top surface of the carrier.

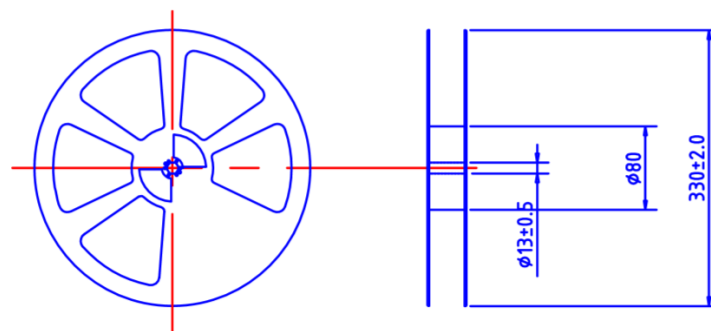

ANTI-STATIC

REEL DIMENSION	Type	Color	Size	Hub
		PS	Black	$\phi 330$



Environmental

Material Regulation

The antenna has been tested to conform to RoHS requirements. A certificate of conformance is available upon request.

This product is Halogen free.



Synzen Precision Technology Ltd



Synzen Precision Technology Ltd makes no warranties based on the accuracy or completeness of the contents of this document and reserves the right to make changes to specifications and product descriptions at any time without notice. Synzen reserves all rights to this document and the information contained herein. Reproduction use or disclosure to third parties without express permission is strictly prohibited.