



**5G / 4G LTE / LTE450 FR4 Antenna with Cable**

**SZK-C-3L29**

450-470; 617-960; 1420-1660; 1710-2200; 2300-2400; 2500-2690; 3300-4200; 4400-5000MHz

**Description**

A Flexible antenna for 5G/4GLTE/LTE 450/NB-IoT/CATM applications. For use internal to a device which requires an integrated antenna solution. High performance with a small form factor for simple integration.

- For 5G/4G LTE/LTE450 and NB-IoT LTE Applications.
- Simple integration, plug and operate the device without designing onboard antenna.
- Small form factor of 100.0 x 20.0 x 0.60 (mm)
- Alternate cable lengths and connectors available upon request, contact [sales@synzen.com.tw](mailto:sales@synzen.com.tw)

**Applications**

Payment Terminals  
Smart Grid

M2M Industrial  
Healthcare

Smart Meters  
Tracking

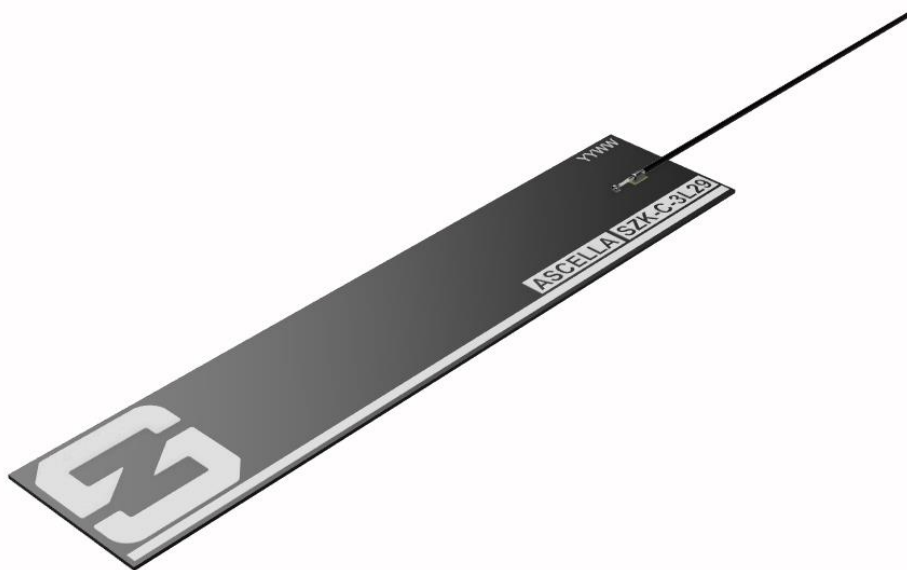



## General Specifications

### Mechanical Specifications

Part Number	SZK-C-3L29
Name	ASCELLA
Dimensions	100.0 x 20.0 x 0.20 (mm)
Weight	<0.5g
Antenna Type	FR4 Self-Adhesive
Cable Length	300mm
Cable type	Mini Coax $\varnothing$ 1.13mm
Connector	MHFI (U. FL Compatible)
Adhesive backing	3M 468

### RF Specifications

5G/4G LTE/NB-IoT Bands	Frequency Range (MHz)	Efficiency (%)	Peak Gain (dBi)	Impedance	Polarization
B31	450-470	>20	-4.40	50 $\Omega$	Linear
B5,8,12,13,14,18,19,20,26,27,28,85	617-960	>50	3.70		
B11,21,32,74	1427-1660	>50	3.30		
B1,2,3,4,9,23,35,39,66	1710-2200	>50	1.40		
B40	2300-2400	>50	2.90		
B7,38,41	2500-2690	>50	3.20		
B42,43,48,77,78	3300-4200	>70	6.20		
B79	4400-5000	>40	4.90		

### Environmental Specifications

Operational Temperature	-40 to +85 (°C)
Storage Temperature	-10 to +40 (°C)
Relative Humidity	≤75%



## 4G LTE Bands

### Supported Band List

Band	Frequency Band	Uplink(MHz)	Downlink (MHz)	Supported
1	2100	1920-1980	2110-2170	YES
2	1900	1850-1910	1930-1990	YES
3	1800	1710-1785	1805-1880	YES
4	1700	1710-1755	2110-2155	YES
5	850	824-849	869-894	YES
7	2600	2500-2570	2620-2690	YES
8	900	880-915	925-960	YES
9		1749.9-1784.9	1844.9-1879.9	YES
10	1700	1710-1770	2110-2170	YES
11	1500	1427.9-1447.9	1475.9-1495.9	YES
12	700	699-716	729-746	YES
13	700	777-787	746-756	YES
14	700	788-798	758-768	YES
17	700	704-716	734-746	YES
18	850	815-830	860-875	YES
19	850	830-845	875-890	YES
20	800	832-862	791-821	YES
21	1500	1447.9-1462.9	1495.9-1510.9	YES
22	3500	3410-3490	3510-3590	YES
24	1600	1626.5-1660.5	1525-1559	YES
25	1900	1850-1915	1930-1995	YES
26	850	814-849	859-894	YES
27	800	807-824	852-869	YES
28	700	703-748	758-803	YES
29	700	N/A	717-728	YES
30	2300	2305-2315	2350-2360	YES
31		452.5-457.5	462.5-467.5	YES
32	1500	N/A	1452-1496	YES
33	2100	1900-1920		YES
34	2100	2010-2025		YES
35	1900	1850-1910		YES
36	1900	1930-1990		YES
37		1910-1930		YES
38	2600	2570-2620		YES
39	1900	1880-1920		YES
40	2300	2300-2400		YES
41	2500	2496-2690		YES
42	3500	3400-3600		YES
43	3700	3600-3800		YES
44	700	703-803		YES
45	1500	1447-1467		YES
46	5200	5150-5925		No
47	5900	5855-5925		No
48	3600	3550-3700		YES
50	1500	1430-1517		YES
51	1500	1427-1432		YES
65	2100	1920-2010	2110-2200	YES
66	1700	1710-1780	2110-2200	YES
67	700	N/A	738-758	YES
68	700	698-728	753-783	YES
69	2600	N/A	2570-2620	YES
70	2000	1695-1710	1995-2020	YES
71		663-698	617-652	YES
74		1427-1518		YES
77		3300-4200		YES
78		3300-3800		YES
79		4400-5000		YES
85		698-716	728-746	YES



## RF Characteristics

### S11 Parameter

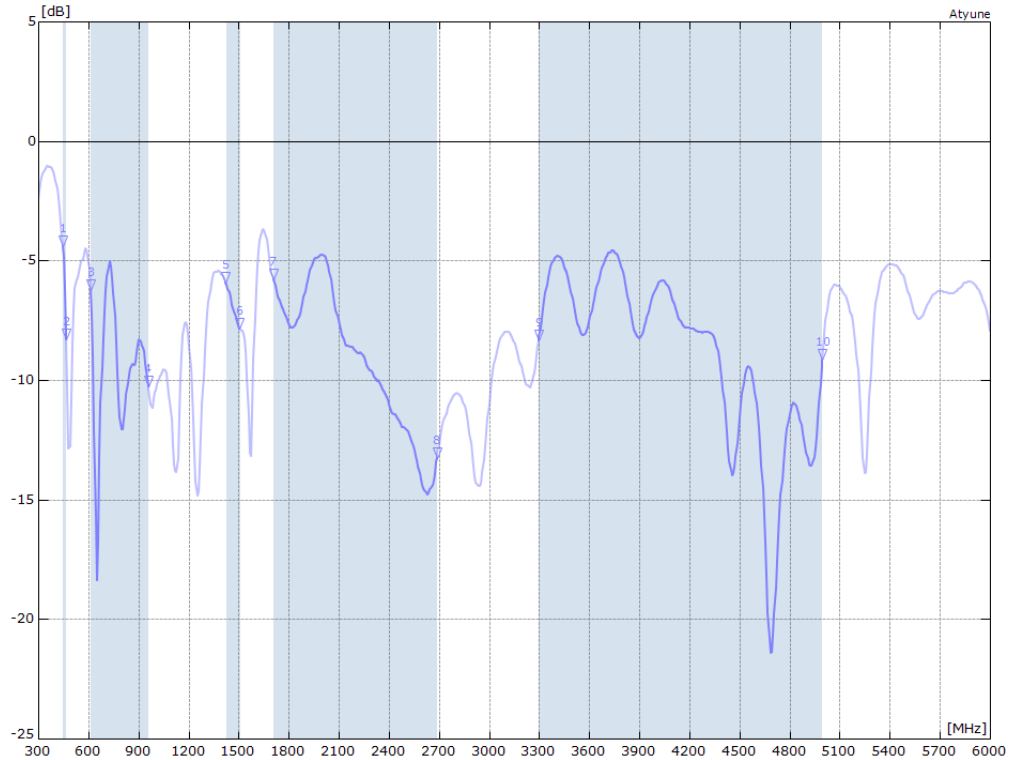

### VSWR

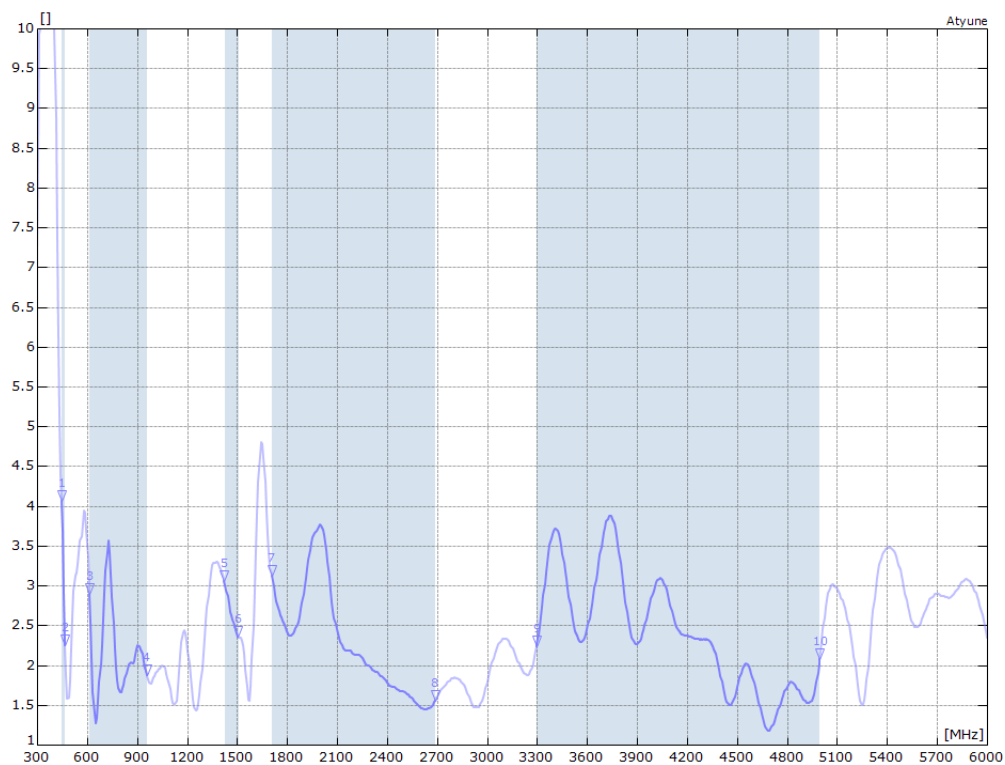



## Antenna Performance

### Efficiency

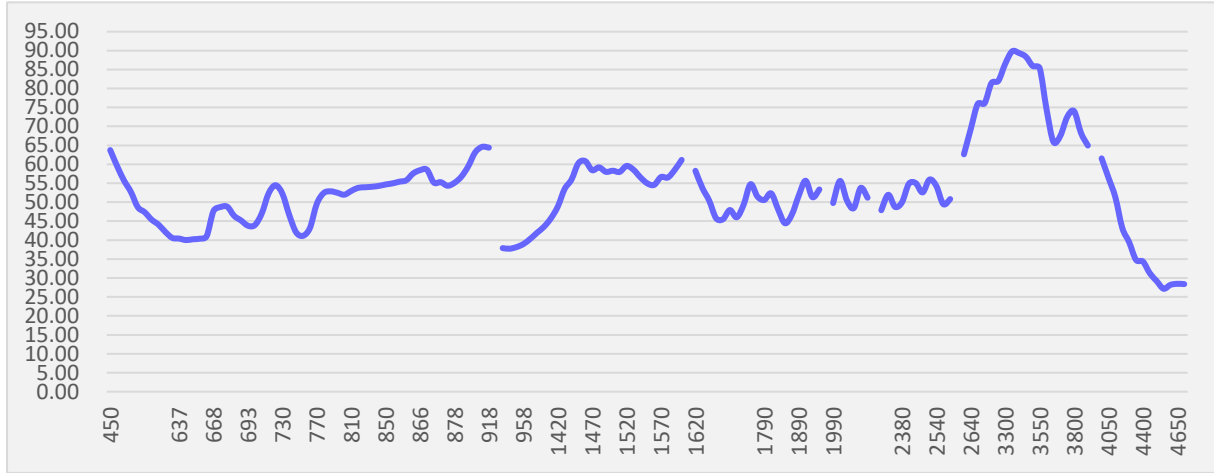

### Peak Gain

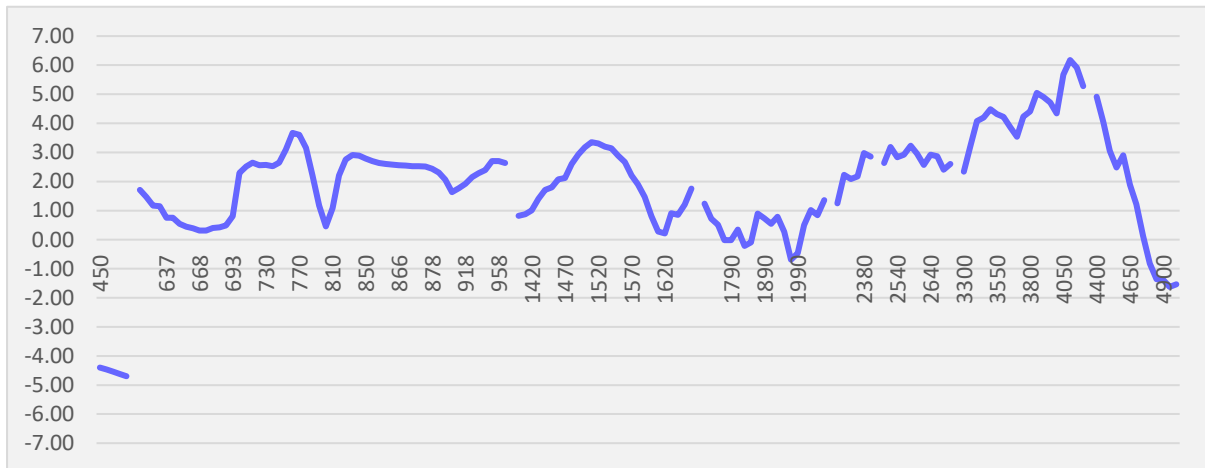

### Average Gain

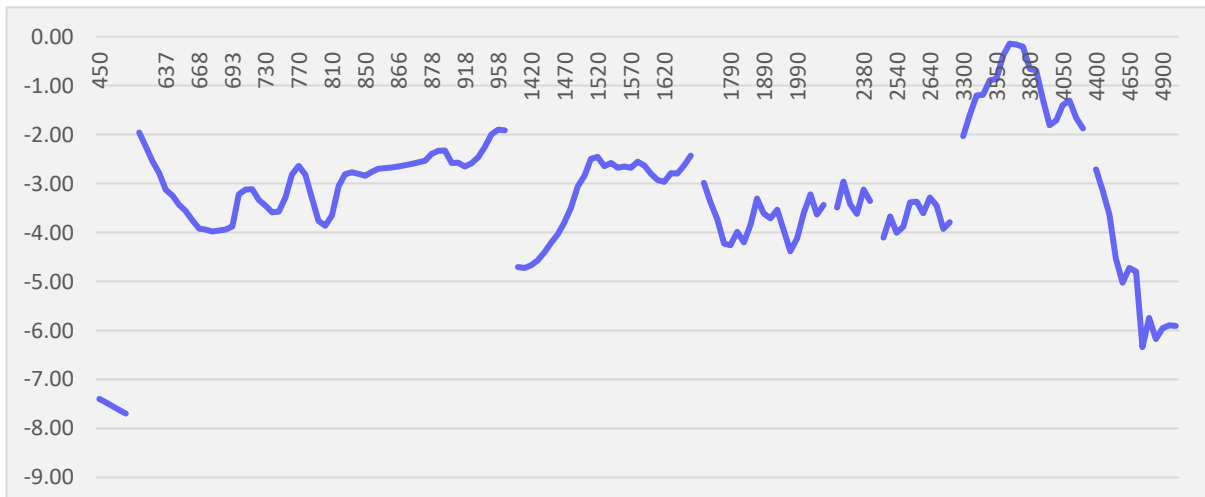



# Radiated Performance

## 2D Polar Plot 698-2690MHz

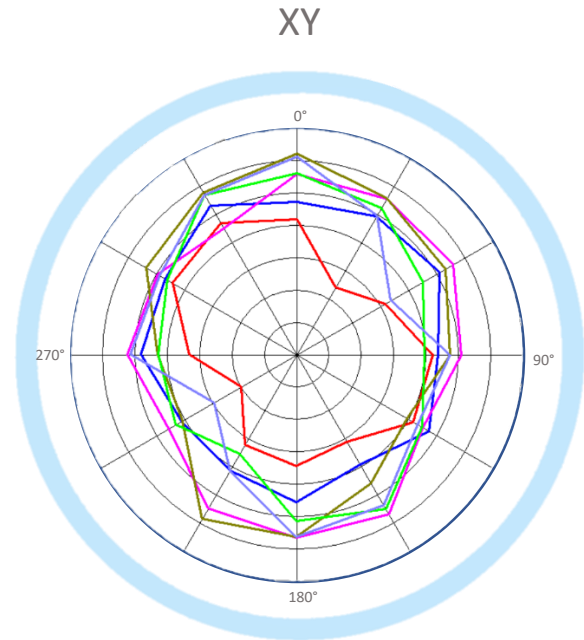
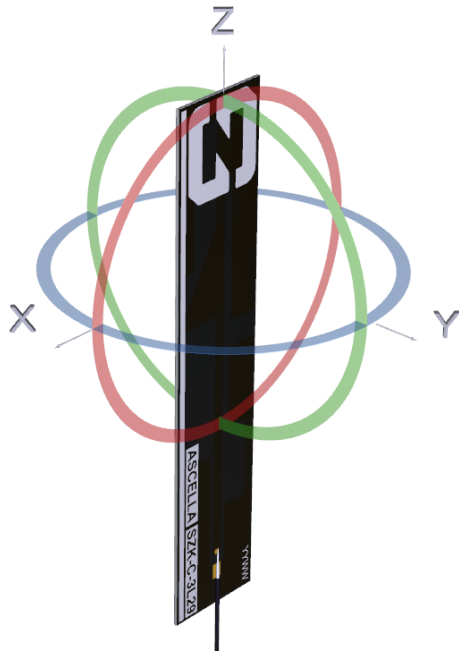

440	Max: 5
714	Min: -30
870	Scale: 5/div
1870	
2380	
2600	

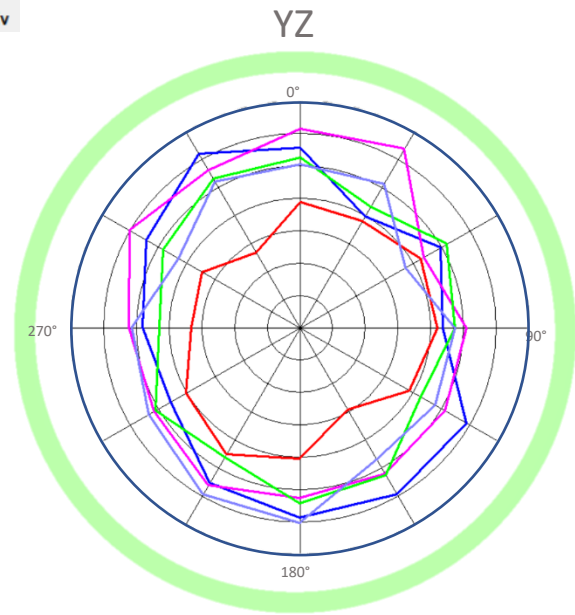
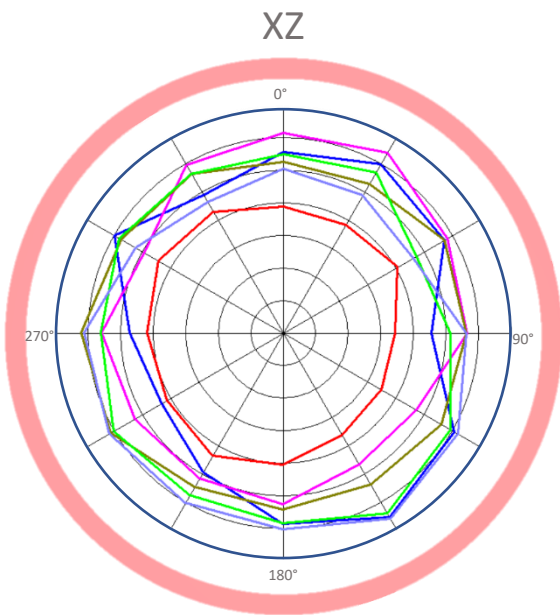



## Radiated Performance

### 3D Radiation Pattern at 880MHz

The frequency point shown here is 880MHz.

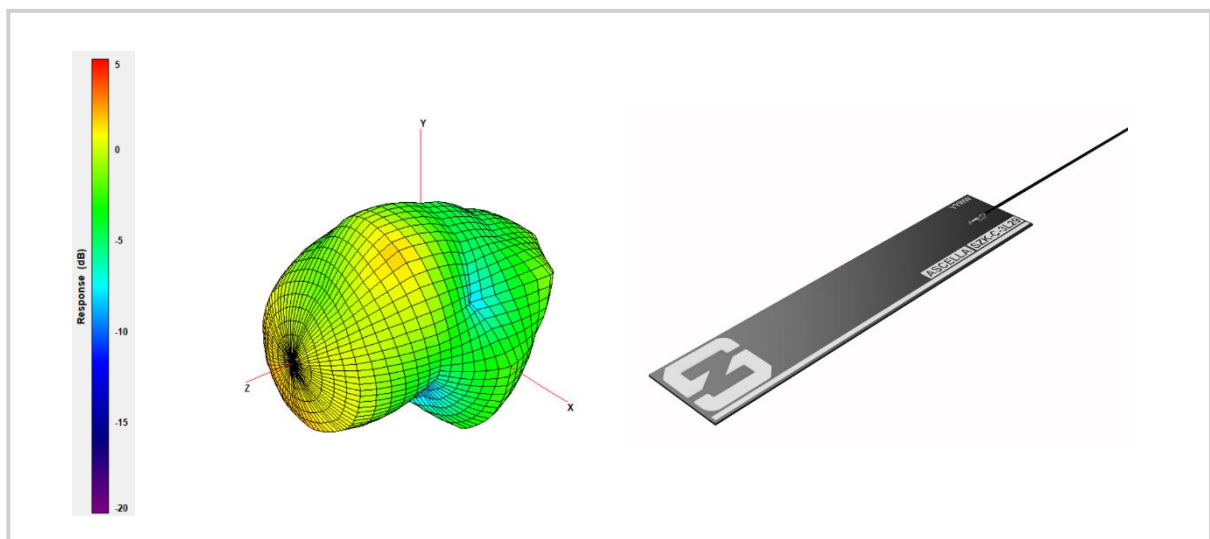
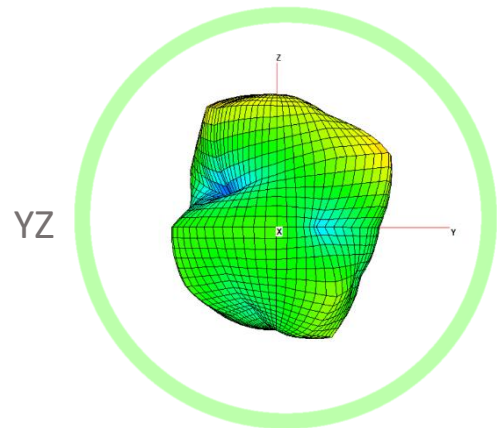
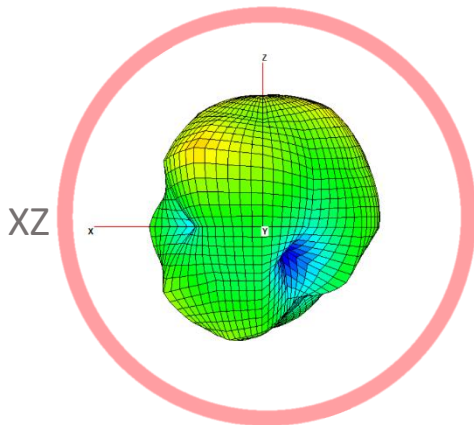
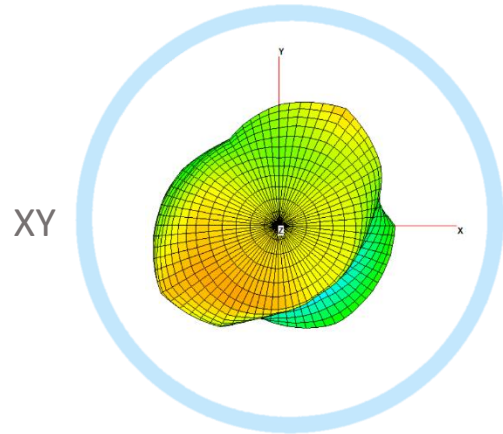
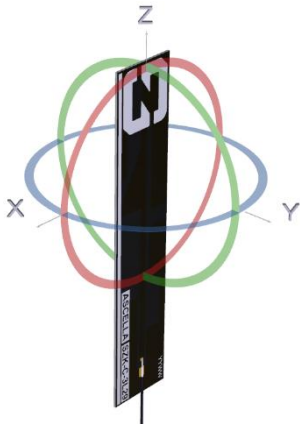



## Radiated Performance

### 3D Radiation Pattern at 1880MHz

The frequency point shown here is 1880MHz.

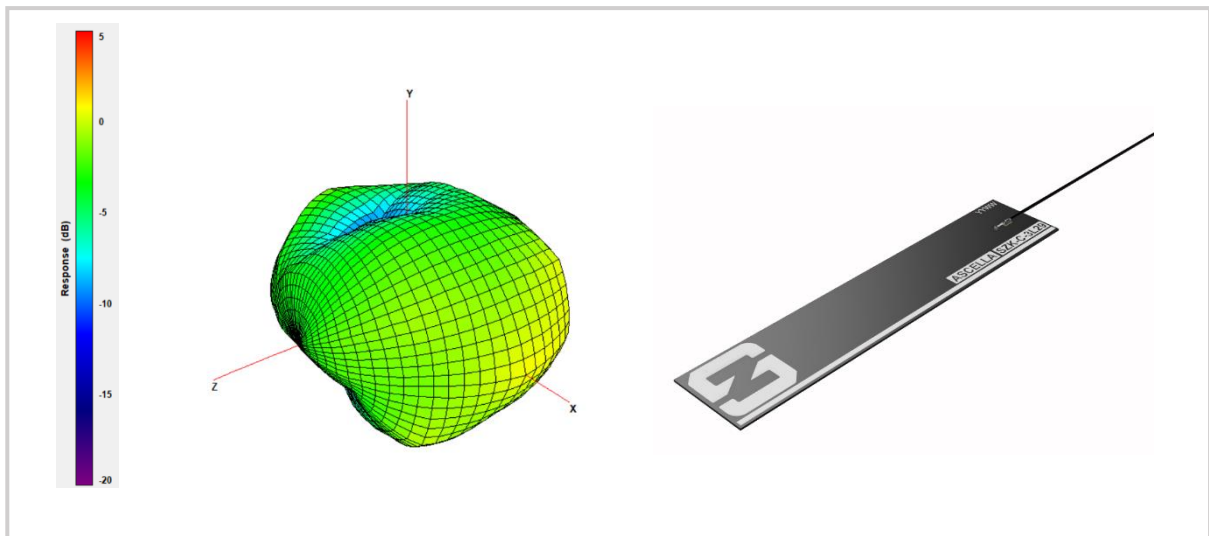
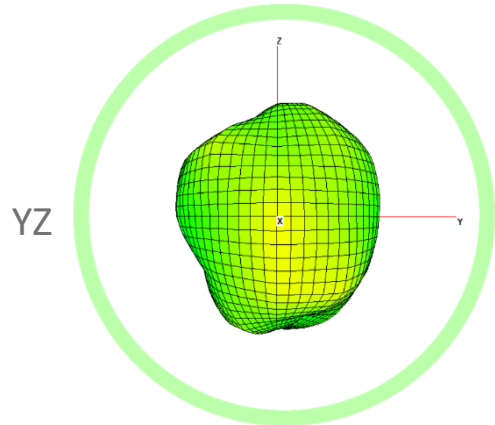
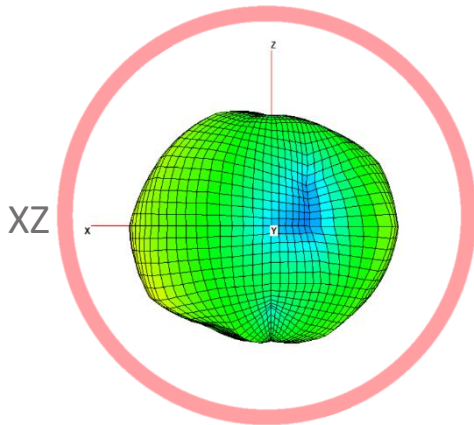
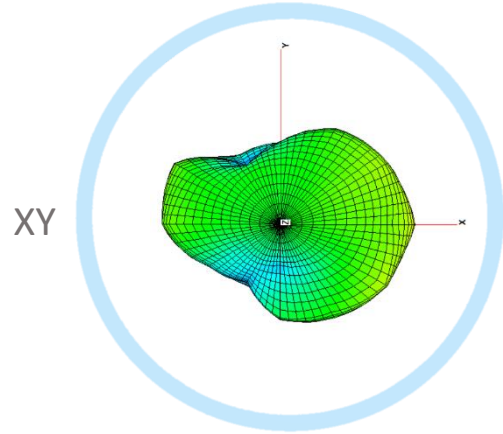
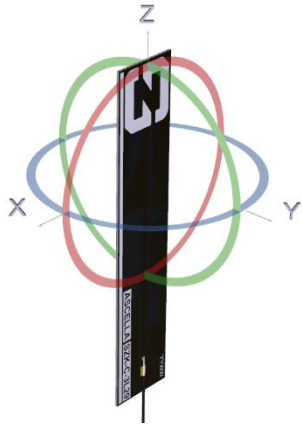





## Radiated Performance

### 3D Radiation Pattern at 2600MHz

The frequency point shown here is 2600MHz.

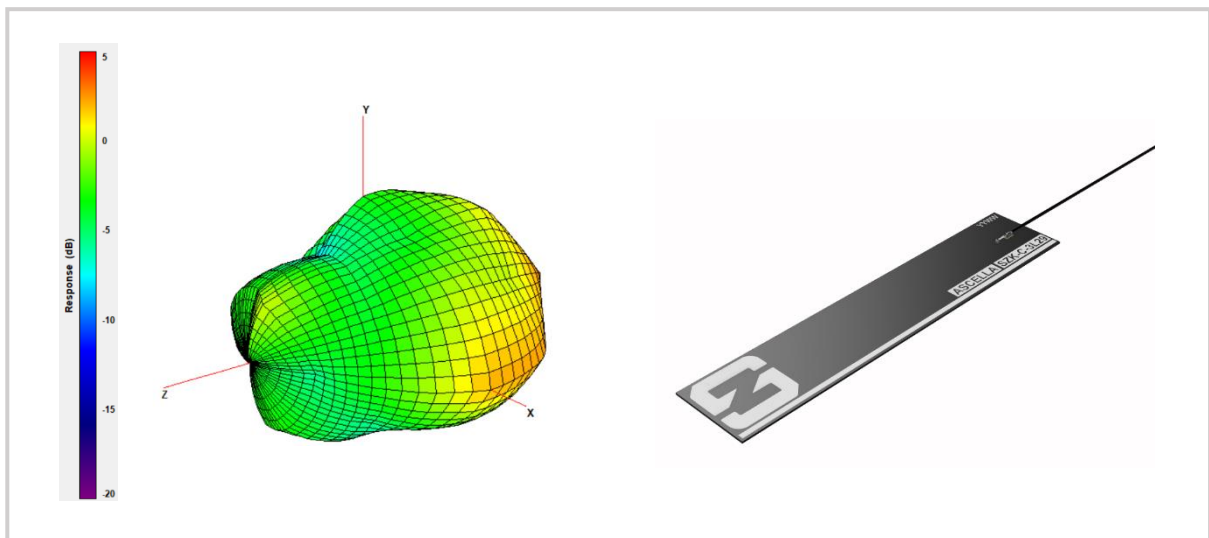
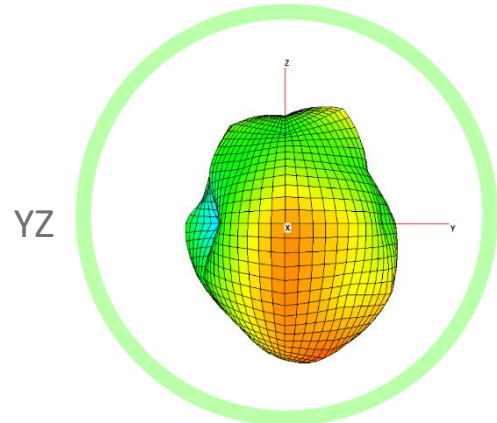
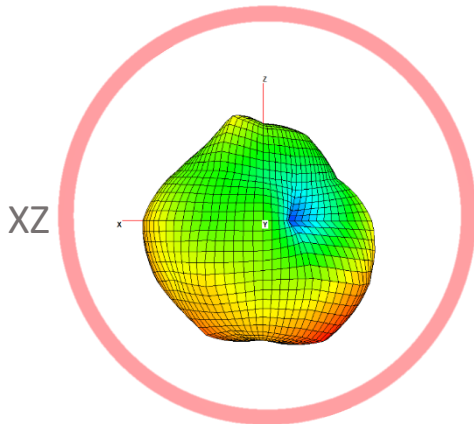
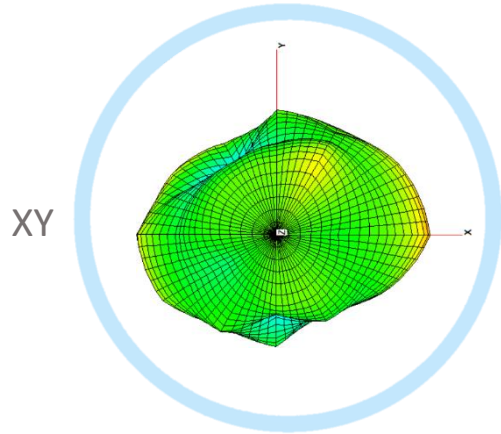
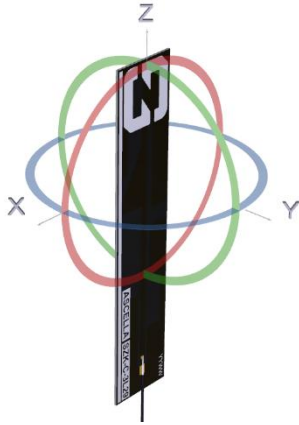



## Mechanical

### Antenna Mechanical Drawing

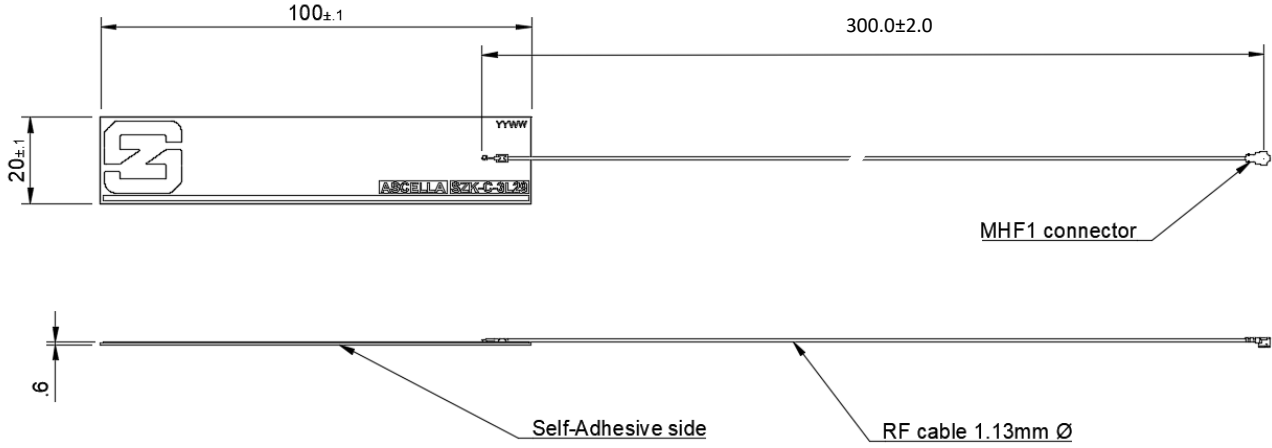

All Dimensions in mm

The plug connector on the antenna is an IPEX MHFI.

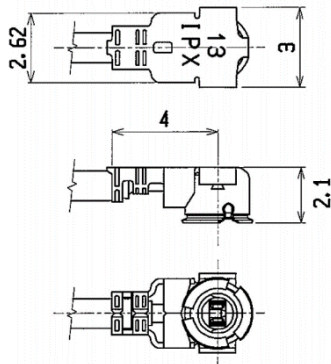

**Suitable PCB mating connector (U.FL) example**

**Joymax:** Model: CT-MPB01X

[www.joymax.com.tw](http://www.joymax.com.tw)

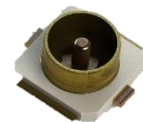

### Adhesive Backing

The antenna comes with 3M 468 adhesive backing upon a PI Kapton substrate. An easy peel cut is on the back side for easy cover removal.



## Packaging



### Bag and Packaging Information

Antennas packed in PE bag (20 per bag)

Small bag dimensions: 28.5 x 9.5 (cm)

100pcs per larger PE bag with product label

Bag dimensions = 30 x 19 (cm)

		<b>SYNZEN</b>
		SYNZEN PRECISION TECHNOLOGY
Part Number:	SZK-C-3L29-300-01	
		
Description :	5G/LET450 FR4 Antenna 300mm cable MHFI	
Name:	ASCELLA	A3, 4F, No. 58, Zhouzi St, Neihu Dist., Taipei City, 11493, Taiwan
Quantity:	100	Tel: +886 (02) 2659 8030
Date Code:	YYWW	www.synzen.com.tw

#### Label

1. 1000pcs per carton
2. Carton dimensions = 33.7 x 32.2 x 10 (cm)



## Environmental

### Material Regulation

The antenna has been tested to conform to RoHS requirements. A certificate of conformance is available upon request.

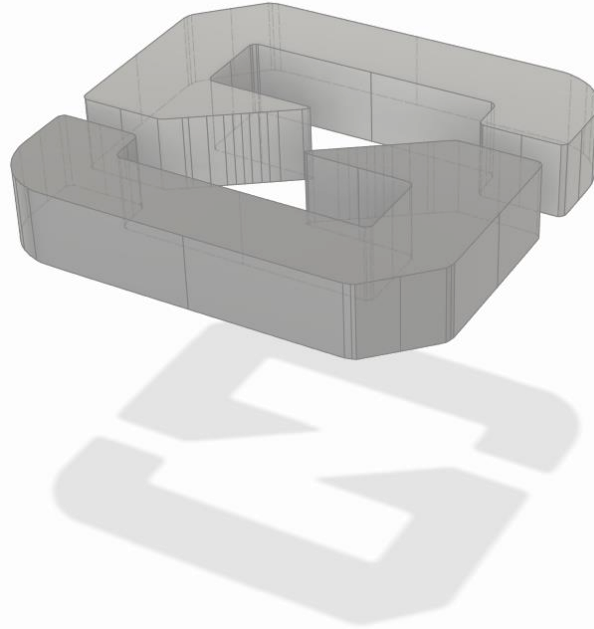

Synzen Precision Technology Ltd makes no warranties based on the accuracy or completeness of the contents of this document and reserves the right to make changes to specifications and product descriptions at any time without notice. Synzen reserves all rights to this document and the information contained herein. Reproduction use or disclosure to third parties without express permission is strictly prohibited.